



Quality Through Innovation Since 1987

Linear Systems Headphone Amplifier Evaluation Board

Linear Integrated Systems headphone amplifier evaluation board

Dimitri Danyuk

Contents

1	Introduction	1
1.1	Features	1
1.2	Description	1
1.3	Specifications	2
2	Operation	2
2.1	Precautions	2
2.2	Quick start list for evaluation board	2
3	Circuit description	3
4	Measurements	4
5	References	8
6	Documents	9
6.1	Linear Integrated Systems headphone amplifier evaluation board schematic diagram	
6.2	Linear Integrated Systems headphone amplifier evaluation board parts list	
6.3	Linear Integrated Systems headphone amplifier evaluation board PCB Layers	

1 Introduction

1.1 Features

Linear Integrated Systems headphone amplifier evaluation board includes the following features:

Stereo, single-ended input and single-ended output

400 mW output power into 100 Ω

Wide frequency response (10Hz-200kHz; -1dB)

Voltage gain 5 (14dB)

Low distortion (THD+N is less than 1% at 10Hz-20kHz at 5Vrms into 100 Ω and less than 0.1% from 10 Hz to 20 kHz at 1Vrms into 100 Ω load)

Short-circuit protection

Pop reduction (slow start) circuit

Defeatable cross-feed circuit

Volume control

Overvoltage and reverse polarity power protection

Audio input and output connections: left and right RCA phono jack inputs, 1/4" stereo phone jack output

External 9V–16V supply input

External power supply connector: power jack, inside diameter 2.1mm, outside diameter 5.5mm

1.2 Description

Linear Integrated Systems

• 4042 Clipper Court • Fremont, CA 94538 • Tel: 510 490-9160 • Fax: 510 353-0261

Linear Integrated Systems headphone amplifier evaluation board is a complete, low-power stereo audio amplifier for high-fidelity line-level output and headphone applications. It consists of Linear Integrated Systems JFETs along with a number of other parts mounted on a circuit board (Fig 1).

1.3 Specifications

Supply voltage range	9V to 16V
Supply current	380mA typ, 850mA max (12V)
Continuous output power, 100Ω load	400 mW/ch, THD+N < 1%
Audio input voltage	1.3 Vrms, max
Minimum load impedance	100 Ω
Maximum output current	55 mA rms

2 Operation

2.1 Precautions

Power supply polarity and maximum voltage

Always ensure that the polarity and voltage of the external power connected to power jack J1 is correct. Overvoltage or reverse-polarity power applied to J1 may damage onboard transient voltage suppression (TVS) diode, onboard DC-DC converter and cause damage to the power source. Please note that onboard DC-DC converter has overvoltage protection, amplifier is not powered, if the power source voltage is greater than 16V.

2.2 Quick start list for evaluation board

- 1) Select and connect a 9V–16V power source to a power jack J1
- 2) Ensure that signal source level is set to minimum
- 3) Connect the audio source to left and right RCA phono jacks J2 and J4
- 4) Connect the load (headphones) to headphone jack J3.
- 5) Verify correct voltage and input polarity according to the silkscreen placed near J1 and set the external power supply to ON. On-board LEDs (D3,D8,D103,D108) light indicate the presence of power
- 6) Adjust the signal source level as needed with volume potentiometer (R139)
- 7) Enable cross-feed circuit by pressing switch SW1

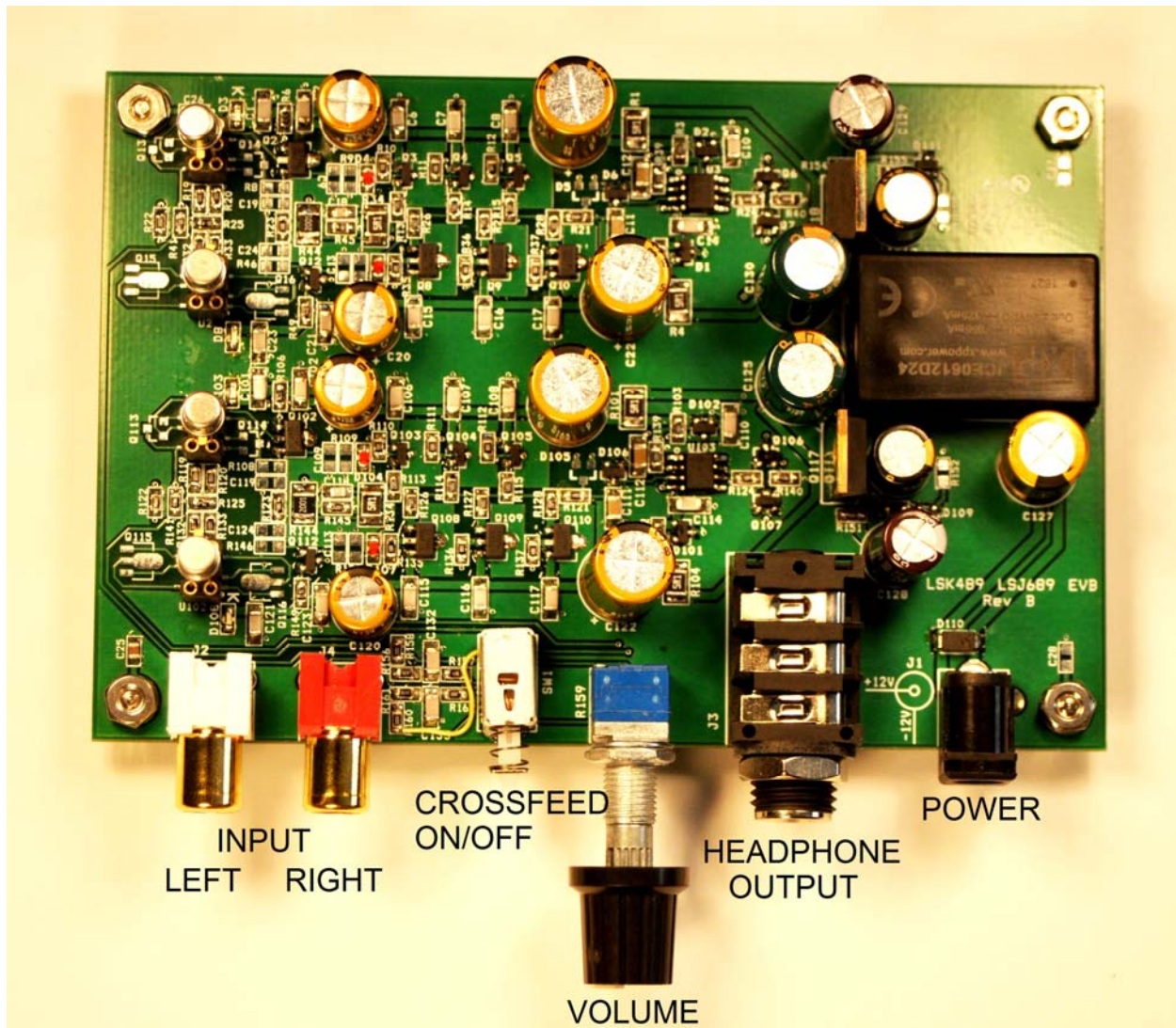

Fig 1 Linear Integrated Systems headphone amplifier evaluation board connections

3 Circuit description

The input stage is a complementary differential JFET stage, based on LSK489 and LSJ689 (U1 and U2). This topology is popular for audio amplifier design (Refs 1-3). Each of these JFETs is working with 4mA drain current. Dual differential JFET input stage can handle fairly large input signals with low distortion. The input stage is loaded with complementary common gate stage, based on LSK170 and LSJ74 (Q12 and Q2). Complementary common gate stage operates at 5mA and provides single ended drive to the output stage. Output stage is a complementary source follower and consists of three LSK170 (Q3-Q5) and three LSJ74 (Q8-Q10). Output devices operate at 10mA each and have large copper pads for heat dissipation. Three JFET pairs in parallel allow driving loads up to 100Ω. Limiter diodes D4 and D7 prevent excessive source current in the output devices when the output of the amplifier is shorted. Gate resistors (R10-R12, R35-37) prevent parasitic oscillation in the output stage.

Amplifier has open loop gain of 48dB with the cutoff frequency equal to 16kHz. The open loop gain determined by transconductance of the input stage and the common gate stage output impedance. Open loop cutoff frequency determined by the common gate stage output impedance and input capacitance of the output complementary follower.

Close loop gain equal to 20dB. R34 isolates the output of complementary source follower from capacitive load; C18 removes overshoot on the output square wave with capacitive loads.

Operational amplifier U3 with bipolar junction transistors Q6 and Q7 form a servo circuit, which maintains zero dc offset on the output terminal. Time constant of the servo circuit is about 1 sec.

Amplifier has switchable passive cross-feed circuit (R156-R162, C132, C133) (Refs. 4,5). Cross-feed helps to reduce listening fatigue caused by the unnatural stereo image localization, provided by headphones. Cross-feed circuit can be disabled by switch SW1 without change in the amplifier output voltage. Passive cross-feed circuit adds 6dB attenuation to the input signal.

Onboard switch mode power supply provides bipolar 24V dc power to MOSFET ripple filters (Q117, Q118). Ripple filters supply left and right channels with bipolar 20V dc, perform slow start and allow using considerable value electrolytic capacitors across the rails. Input of the onboard switch mode power supply is protected with TVS diode D110. External power is galvanically isolated from amplifier circuit.

4 Measurements

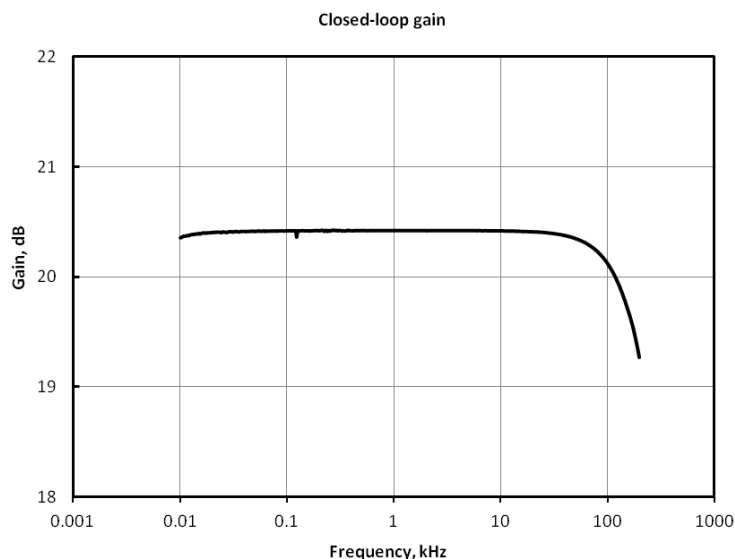

Fig.2 Closed-loop gain for Linear Integrated Systems headphone amplifier as a function of frequency. Cross-feed circuit is disabled (R158=R160=0)

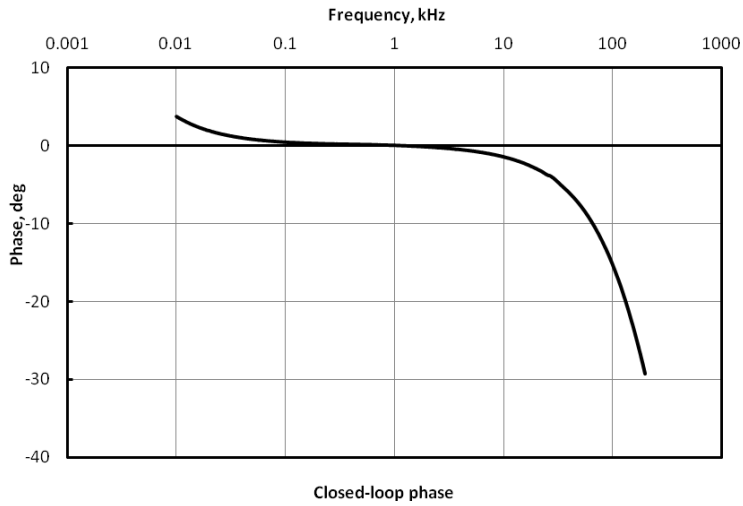

Fig.3 Closed-loop phase as a function of frequency. Cross-feed circuit is disabled (R158=R160=0).

The headphone preamplifier offers wide bandwidth (Fig.2, Fig.3). At 200kHz the frequency response is down by 1dB and phase shift is -30°.

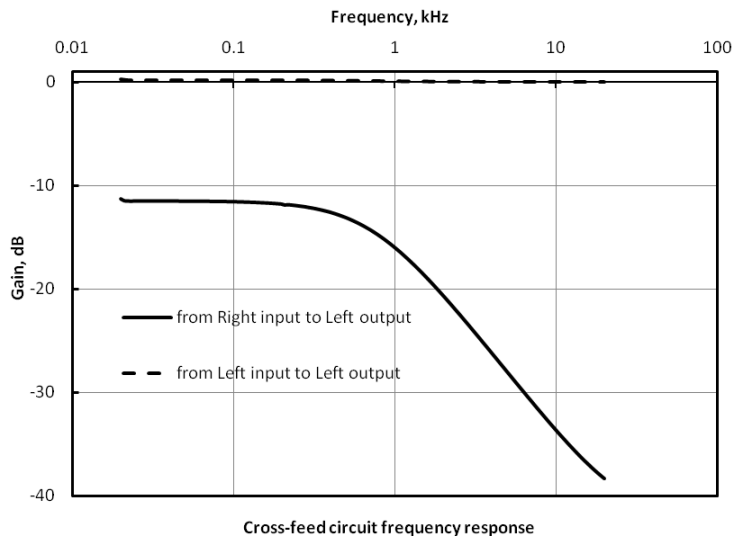

Fig.4 Cross-feed circuit frequency response

Fig.4 shows the frequency response for the crossfeed-signal (from Right input to Left output) as well as the direct audio signal (from Left input to Left output). The amplitude of the crossfeed-signal decreases with frequency, and thus mimics the shadowing effect of the head at higher frequencies.

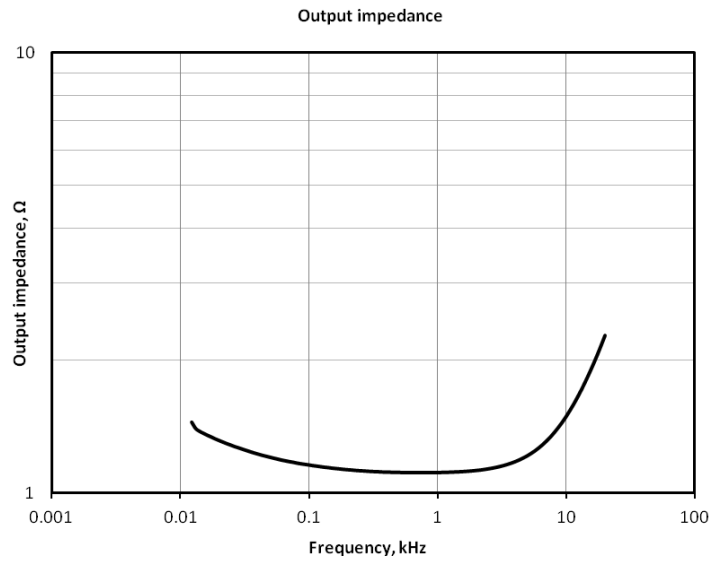

Fig.5 Output impedance of Linear Integrated Systems headphone amplifier as a function of frequency.
Output current 10mA

The output impedance (Fig.5) is below 1.5 Ω at low and middle frequencies, rising slightly to just under 2.5 Ω at the top of the audio band.

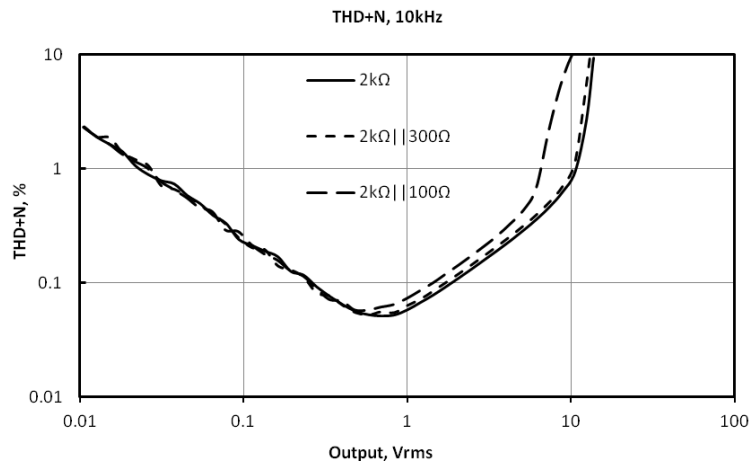

Fig.6 Total harmonic distortion plus noise (THD+N) for Linear Integrated Systems headphone amplifier as a function of output voltage.

Figs. 6 plots how the percentage of THD+N in the headphone amplifier output changes into 100Ω, 300Ω and 2kΩ load. The clipping level exceeds 10V rms for 300Ω and 2kΩ. For 100Ω load clipping level is above 7V rms. The increase in distortion into lower impedances caused by limiting of the output current by internal short circuit protection. There is a weak dependance between THD+N and the load impedance.

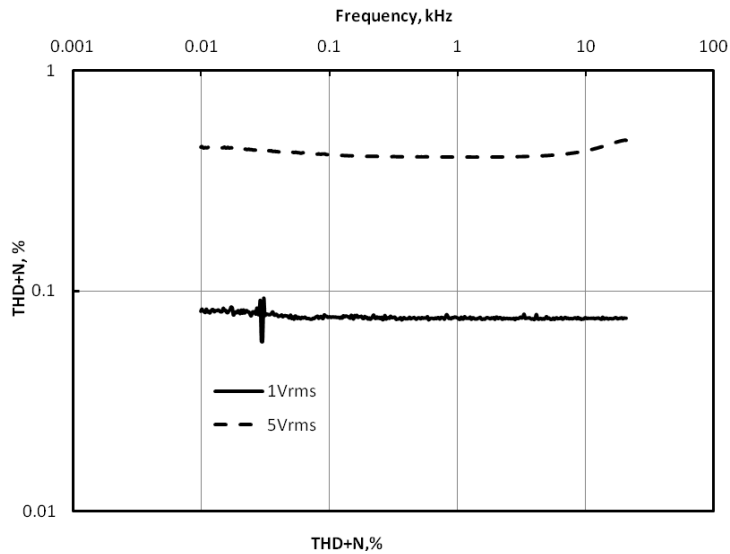

Fig.7 Total harmonic distortion plus noise (THD+N) for Linear Integrated Systems headphone amplifier as a function of frequency

Fig.7 plots the THD+N percentage against frequency at 1V rms and 5Vrms output. The THD+N rises slightly at the top of the audioband at 5V rms outout

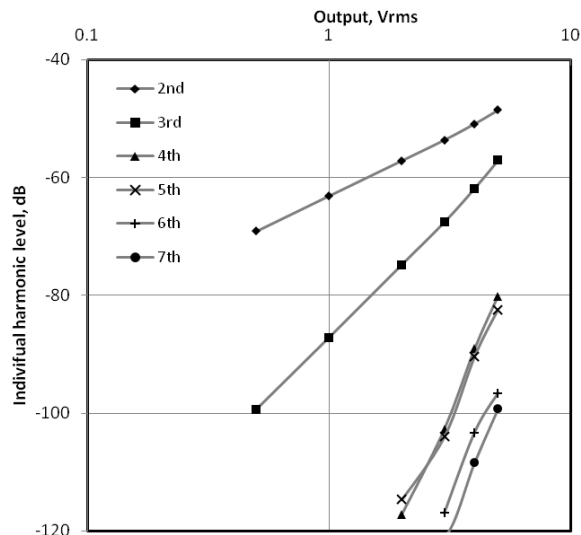

Fig.8 Individual harmonic levels for Linear Integrated Systems headphone amplifier as a function of output voltage. Load 100Ω.

At low output, the distortion is primarily the second harmonic (Fig. 8), at high output levels this is joined by third harmonic at 10dB less level. Higher order products are regularly distributed. Levels of the fourth and fifth harmonic are at least 20dB less than the level of third. Sixth and seventh harmonic levels are about 100dB less than fundamental.

5 References

- 1 J.Curl, "JC-2 Preamplifier", The Audio Amateur, 1977, No 3, p.48
- 2 J.Curl, "JC-3 Power Amplifier", The Audio Amateur, 1981, No 2, p.56, reprinted in Electronics World, April 2000, p.342
- 3 E.Borbely, "Starter Kits: EB-604/410 All-JFET Line Amp", AudioXpress, March 2005, pp.9-15.
- 4 D.Danyuk, "Adjustable Crossfeed Circuit for Headphones," Electronics World, August 2005, p.46
- 5 "F5-HA Discrete All FET Class A Headphone Amplifier"

Related documentation from Linear Integrated Systems:

[LSJ/SST74 Series Datasheet](#)

[LSK170 Series Datasheet](#)

[LSK489 Series Datasheet](#)

[LSJ689 Datasheet](#)

[LSK489 Application Note](#)

[LSJ689 Application Note](#)

6 Documents

- 6.1 Linear Integrated Systems headphone amplifier evaluation board schematic diagram

See attachment

6.2 Linear Integrated Systems headphone amplifier evaluation board parts list

See attachment

6.3 Linear Integrated Systems headphone amplifier evaluation board PCB Layers

The following illustrations portray the Linear Integrated Systems headphone amplifier evaluation board silkscreen, top and bottom layers. These illustrations are not to scale. Gerber files can be obtained from Linear Integrated Systems sales office.

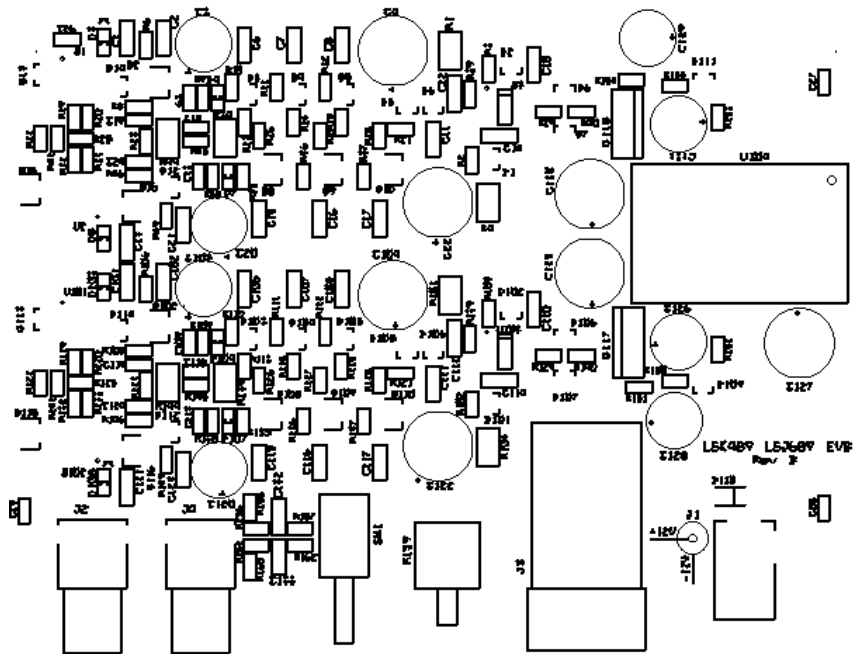

Fig.9 Linear Integrated Systems headphone amplifier evaluation board silkscreen

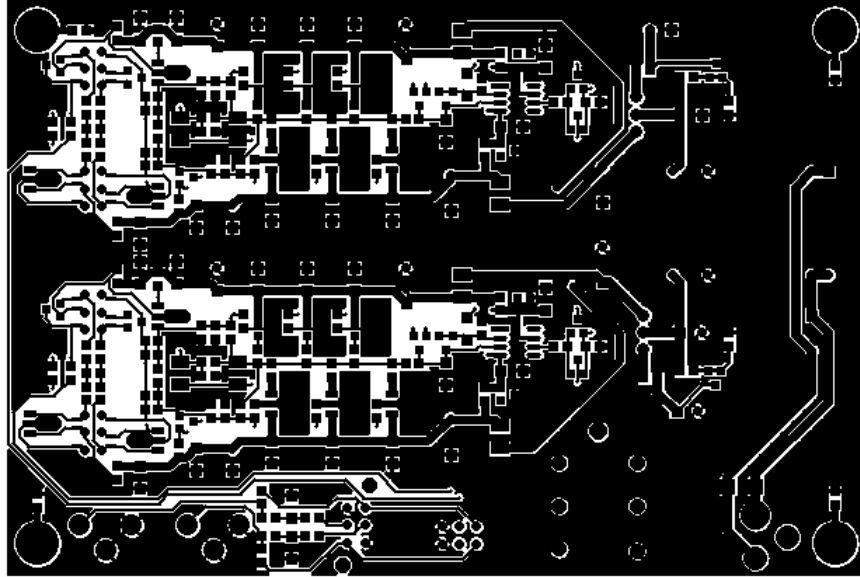

Fig.10 Linear Integrated Systems headphone amplifier evaluation board top layer

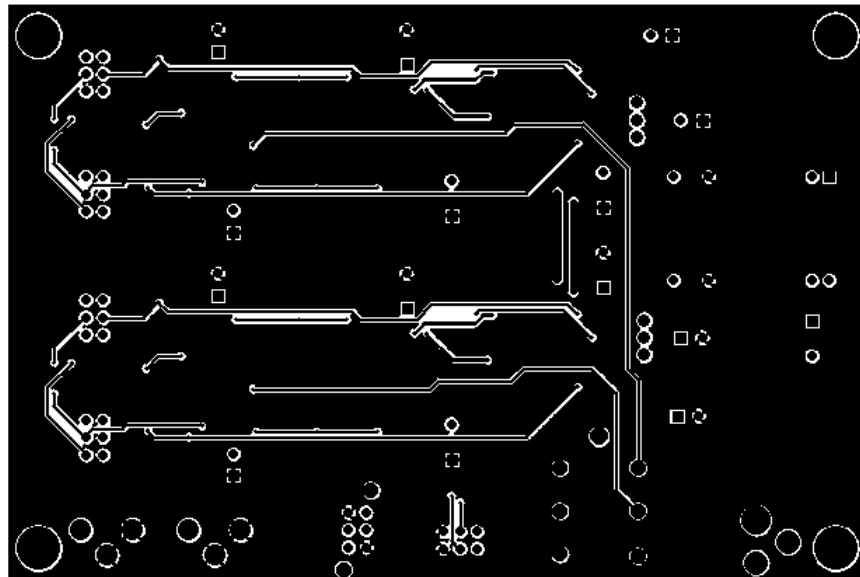
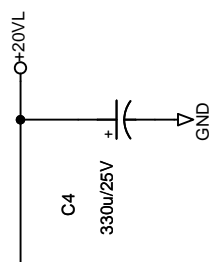
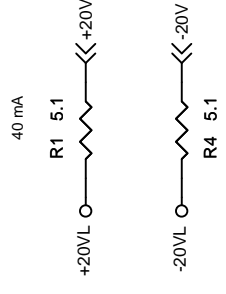

Fig.11 Linear Integrated Systems headphone amplifier evaluation board bottom layer



0.5"x0.5" copper pad for Q3-Q5 pin 3

0.5"x0.5" copper pad for Q8-Q10 pins 2,4

Open loop gain 48 dB
 Open loop -3dB cutoff 16 kHz
 THDN open loop 0.2% 1 V output
 Close loop gain 20 dB

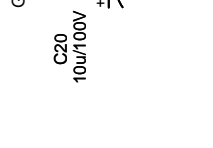
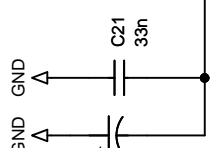
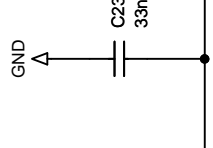
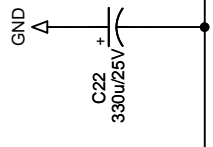
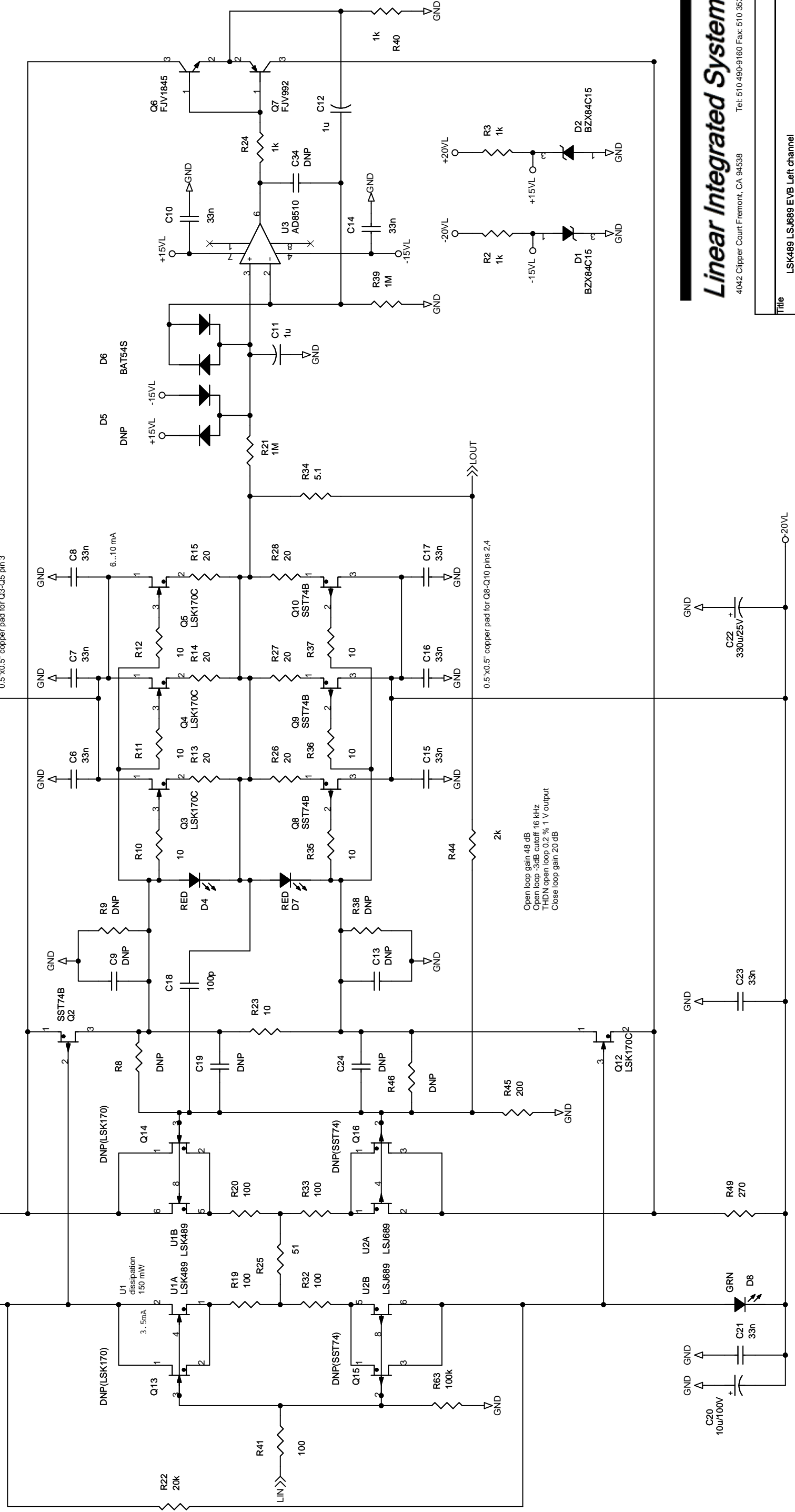

Linear Integrated Systems

4042 Clipper Court Fremont, CA 94538
 Tel: 510-490-9160 Fax: 510-353-0261

Title	LSK489 LSJ689 EVB Left channel
Size	Document Number
Customer	Customer-Doc
Date	Saturday, September 10, 2016
Sheet	1 of 3
Rev	C

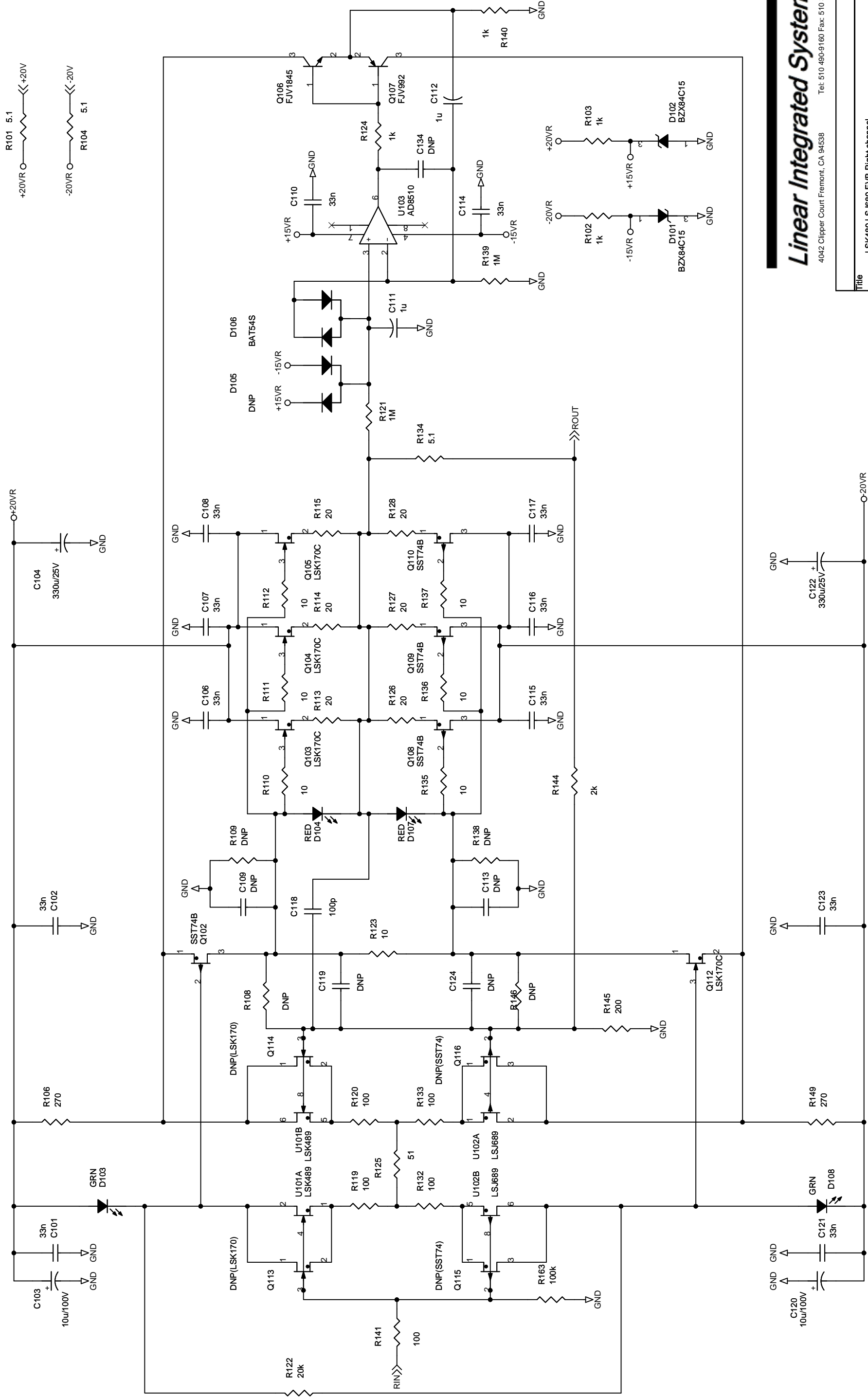

Linear Integrated Systems
 4042 Clipper Court Fremont, CA 94538
 Tel: 510 490-9160 Fax: 510 353-0261

Title	LSK489 LSJ689 EVB Right channel
Size	Document Number
Customer	Customr-Doc>
Date:	Friday, September 09, 2016
Sheet	2 of 3
Rev	C

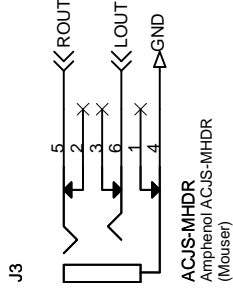
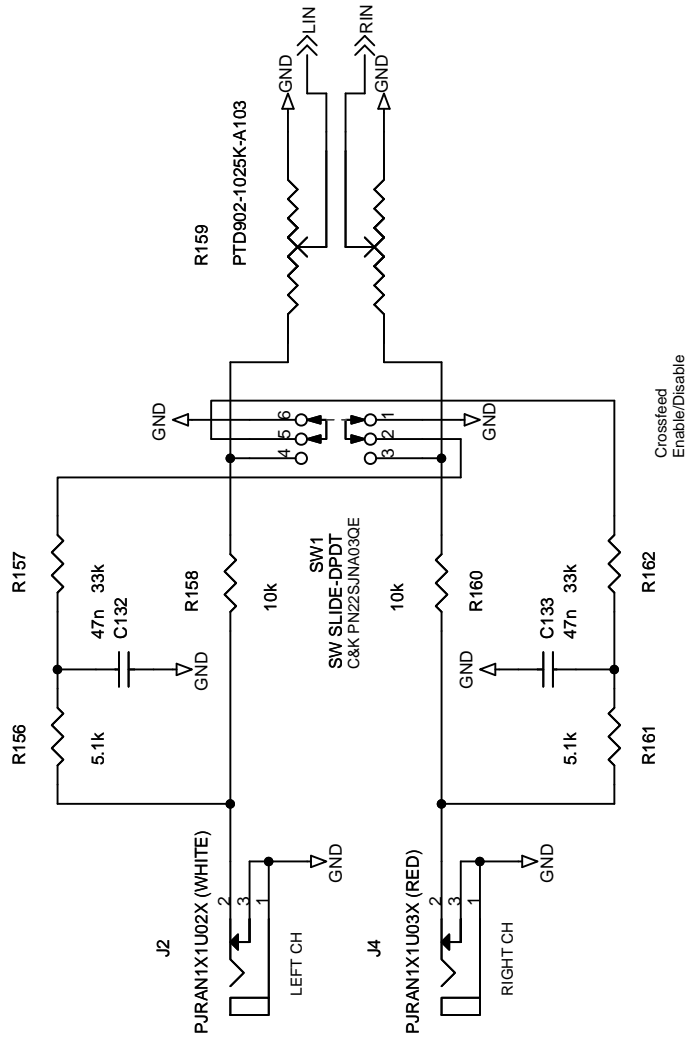
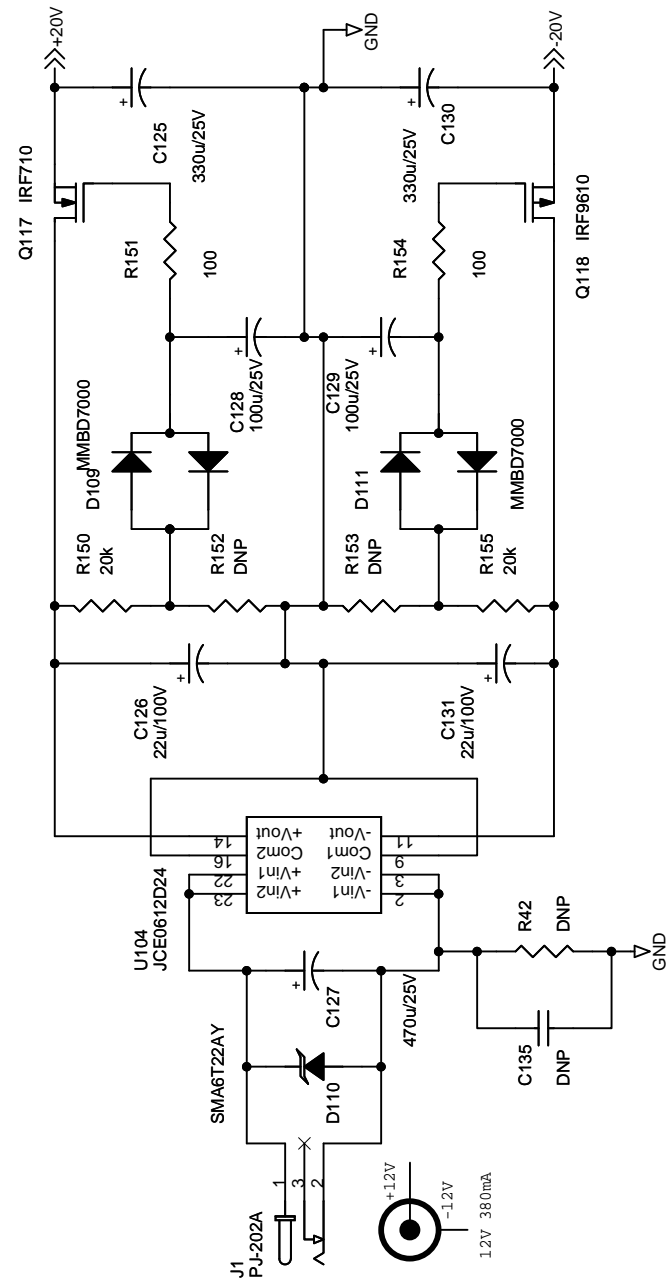
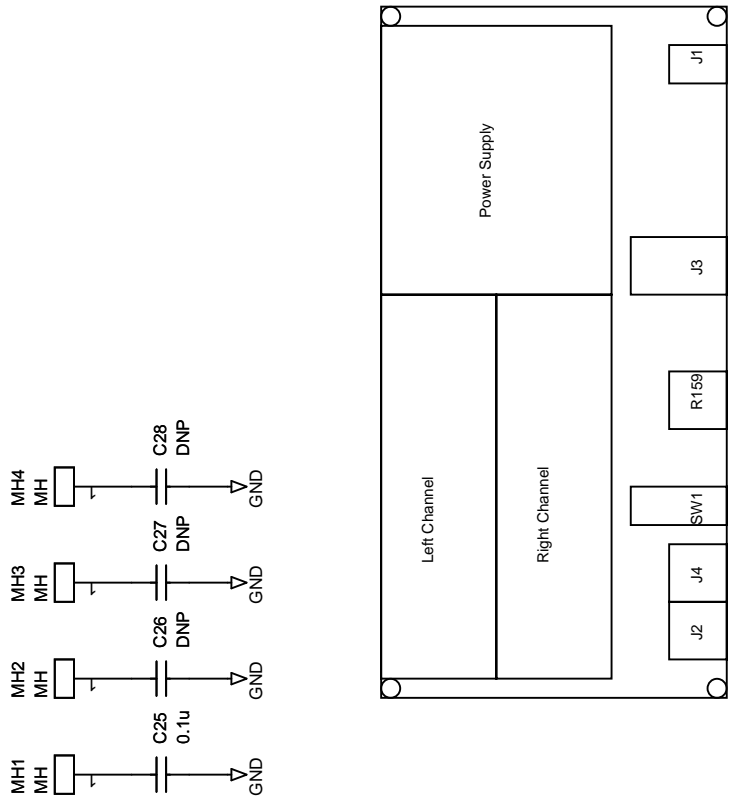

Title	LSK489 LSJ689 EVB Power Supply, Connectors
Size	Document Number
Customer	Customr-Doc>
Date:	Monday, September 12, 2016
Sheet	3 of 3
Rev	C

Bill Of Materials

Item	Quantity	Reference	Part	PCB Footprint	Description	Manufacturer Part Number	Distributor Part Number (Digikey, Mouser)
1	24	C1,C2,C6,C7,C8,C10,C14,C15,C16,C17,C21,C23,C101,C102,C106,C107,C108,C110,C114,C115,C116,C117,C121,C123	33n	1206	0.033µF 100V Ceramic Capacitor COG	C3216C0G2A333J160AA	445-15415-6-ND
2	4	C3,C20,C103,C120	10u/100V	CPCYL1/D.325/LS.125/.034	10µF 100V Aluminum Capacitor Radial	UFG2A100MPM1TD	493-10867-1-ND
3	6	C4,C22,C104,C122,C125,C130	330u/25V	CPCYL1/D.400/LS.200/.034	330µF 25V Aluminum Capacitor Radial	UFG1E331MPPM1TD	493-10914-1-ND
4	23	R8,R9,C9,C13,C19,C24,C26,C27,C28,C34,R38,R46,R108,R109,C109,C113,C119,C124,C134,R138,R146,R152,R153	DNP	805			
5	4	C11,C12,C111,C112	1u	1206	1µF 100V Ceramic Capacitor X7R	C3216X7R2A105M160AA	445-4468-1-ND
6	2	C18,C118	100p	805	100pF 100V Ceramic Capacitor COG	CGA4C2C0G2A101J060AA	445-6951-1-ND
7	1	C25	0.1u	805	0.10µF 100V Ceramic Capacitor X7R	C2012X7R2A104K125AA	445-1418-1-ND
8	2	C126,C131	22u/100V	CPCYL1/D.325/LS.125/.034	22µF 100V Aluminum Capacitor Radial	UKZ1H220MPM	493-3193-ND
9	1	C127	470u/25V	CPCYL1/D.400/LS.200/.034	470µF 25V Aluminum Capacitor Radial	UFW1E471MPD1TD	493-10998-1-ND
10	2	C128,C129	100u/25V	CPCYL1/D.325/LS.125/.034	100µF 25V Aluminum Capacitor Radial	UPW1J101MPD6	493-1937-ND
11	2	C132,C133	47n	1206	0.047µF 100V Ceramic Capacitor COG	C3216C0G2A473J115AC	445-172673-1-ND
12	4	D1,D2,D101,D102	BZX84C15	SOT23	Zener Diode 15V 225mW	BZX84C15LT1G	BZX84C15LT1GOSCT-ND
13	4	D3,D8,D103,D108	GRN	LED_0805	Green 569nm LED Indication - Discrete 2.1V	LTST-CI71GKT	160-1423-1-ND
14	4	D4,D7,D104,D107	RED	LED_0805	Red 631nm LED Indication - Discrete 2V	LTST-CI71KRKT	160-1427-1-ND
15	2	D5,D105	DNP	SOT23			
16	2	D6,D106	BAT54S	SOT23	Diode Array 1 Pair Series Connection Schottky 30V 200mA	BAT54SLT1G	BAT54SLT1GOSCT-ND
17	2	D109,D111	MIMBD7000	SOT23	Diode Array 1 Pair Series Connection Standard 100V 200mA	MIMBD7000LT3G	MIMBD7000LT3GOSCT-ND
18	1	D110	SMA6T22AY	SMA	TVS DIODE 18.8VWM 39.3VC SMA	SMA6T22AY	497-10939-1-ND

19	1	J1	PJ-202A	PJ-202A	Power Barrel Connector Jack 2.00mm ID (0.079"), 5.50mm OD (0.217") Through Hole, Right Angle	PJ-202A	CP-202A-ND
20	1	J2	PJ-202A	PIRANIX1U02X (WHITE)	RCA Phono Connectors 1 POS RA PH JK WHITE	PIRANIX1U02X	502-PJ-RANIX1U02X
21	1	J3	ACJS-MHDR	ACJS-MHDR	Phone Connectors 1/4" PHON SKT STEREO	ACJS-MHDR	523-ACJS-MHDR
22	1	J4	PJ-202A	PJ-202A	RCA Phono Connectors 1 POS RA PH JK RED	PIRANIX1U03X	502-PJ-RANIX1U03X
23	4	MH1,MH2,MH3,MH4	MH	MTGH125-PLATED			
24	8	Q2,Q8,Q9,Q10,Q102,Q 108,Q109,Q110	SST74B	SOT89	Transistor, P-Channel, Single, JFET		
25	8	Q3,Q4,Q5,Q12,Q103,Q 104,Q105,Q112	LSK170C	SOT23	Transistor, N-Channel, Single, JFET		
26	2	Q6,Q106	FJV1845	SOT23	TRANS NPN 120V 0.05A SOT-23	FJV1845FMTF	FJV1845FMTFCT-ND
27	2	Q7,Q107	FJV992	SOT23	TRANS PNP 120V 0.05A SOT-23	FJV992FMTF	FJV992FMTFCT-ND
28	4	Q13,Q14,Q113,Q114	DNP(LSK170)	SOT23			
29	4	Q15,Q16,Q115,Q116	DNP(SS174)	SOT89			
30	1	Q117	IRF710	TO220	MOSFET N-CH 400V 2A TO-220AB	IRF710PBF	IRF710PBF-ND
31	1	Q118	IRF9610	TO220	MOSFET P-CH 200V 1.8A TO-220AB	IRF9610PBF	IRF9610PBF-ND
32	6	R1,R4,R34,R101,R104,R 134	5.1	1210	RES SMD 5.1 OHM 1% 1/2W	ERJ-14BQF5R1U	P17267CT-ND
33	8	R2,R3,R24,R40,R102,R1 03,R124,R140	1k	805	RES SMD 1K OHM 1% 1/8W	ERJ-6ENF1001V	P1.00KCCT-ND
34	4	R6,R49,R106,R149	270	805	RES SMD 270 OHM 1% 1/8W	ERJ-6ENF2700V	P270CCT-ND
35	14	R10,R11,R12,R23,R35,R 36,R37,R110,R111,R11 2,R123,R135,R136,R13 7	10	805	RES SMD 10 OHM 1% 1/8W	ERJ-6ENF10R0V	P10.0CCT-ND
36	12	R13,R14,R15,R26,R27,R 28,R113,R114,R115,R1 26,R127,R128	20	805	RES SMD 20 OHM 1% 1/8W	ERJ-6ENF20R0V	P20.0CCT-ND
37	12	R19,R20,R32,R33,R41,R 119,R120,R132,R133,R 141,R151,R154	100	805	RES SMD 100 OHM 1% 1/8W	ERJ-6ENF1000V	P100CCT-ND
38	4	R21,R39,R121,R139	1M	805	RES SMD 1M OHM 1% 1/8W	ERJ-6ENF1004V	P1.00MCCT-ND
39	4	R22,R122,R150,R155	20k	805	RES SMD 20K OHM 1% 1/8W	ERJ-6ENF2002V	P20.0KCDKR-ND
40	2	R25,R125	51	805			
41	2	R44,R144	2k	1210	RES SMD 2K OHM 1% 1/2W	ERJ-14NF2001U	P2.00KAACT-ND
42	2	R45,R145	200	805	RES SMD 200 OHM 1% 1/8W	ERJ-6ENF2000V	P200CTR-ND
43	2	R63,R163	100k	805	RES SMD 100K OHM 1% 1/8W	ERJ-6ENF1003V	P100KCCT-ND
44	2	R156,R161	5.1k	805	RES SMD 5.1K OHM 1% 1/8W	ERJ-6ENF5101V	P5.10KCCT-ND
45	2	R157,R162	33k	805	RES SMD 33K OHM 1% 1/8W	ERJ-6ENF3302V	P33.0KCDKR-ND
46	2	R158,R160	10k	805	RES SMD 10K OHM 1% 1/8W	ERJ-6ENF1002V	P10.0KCCT-ND
47	1	R159	PTD902-1025K-A103	PTD902	Potentiometer 10K AUDIO	PTD902-1025K-A103	652-PTD902-1025KA103

48	1	SW1	SW SLIDE-DPDT	PN22SJNA03QE	Pushbutton Switch DPDT Standard Through Hole, Right Angle	PN22SJNA03QE	CKN1191-ND
49	2	U1,U101	LSK489	SOIC-8/TO-71	N-Channel Transistor, JFET, 6 Leads, Low Noise, Low Capacitance, Monolithic Dual		
50	2	U2,U102	LSI689	SOIC-8/TO-71	P-Channel Transistor, JFET, 6 Leads, Low Noise, Low Capacitance, Monolithic Dual		
51	2	U3,U103	AD8510	SOIC-8	J-FET Amplifier 1 Circuit 8-SOIC	AD8510ARZ	AD8510ARZ-ND
52	1	U104	JCE0612D24	JCE06	DC/DC CONVERTER +/-24V 6W	JCE0612D24	1470-1924-5-ND
53	4	standoff			HEX STANDOFF 4-40 BRASS 1/4"	8713	36-8713-ND
54	4	nut			#4-40 Hex Nut 0.250"	HNZ 440	H216-ND
55	4	lock washer			WASHER SPLIT LOCK #4	4693	36-4693-ND
56	4	socket for U1,U2,U101,U102 TO-71			6 Position Socket Connector 0.100" (2.54mm) Through Hole Gold	803-87-006-10-001101	1212-1229-ND